

TECHBAR

• Revolutionary Spacer Support Bar and Bracket System for Built Up, Twin Skin Roofing and Cladding Applications •

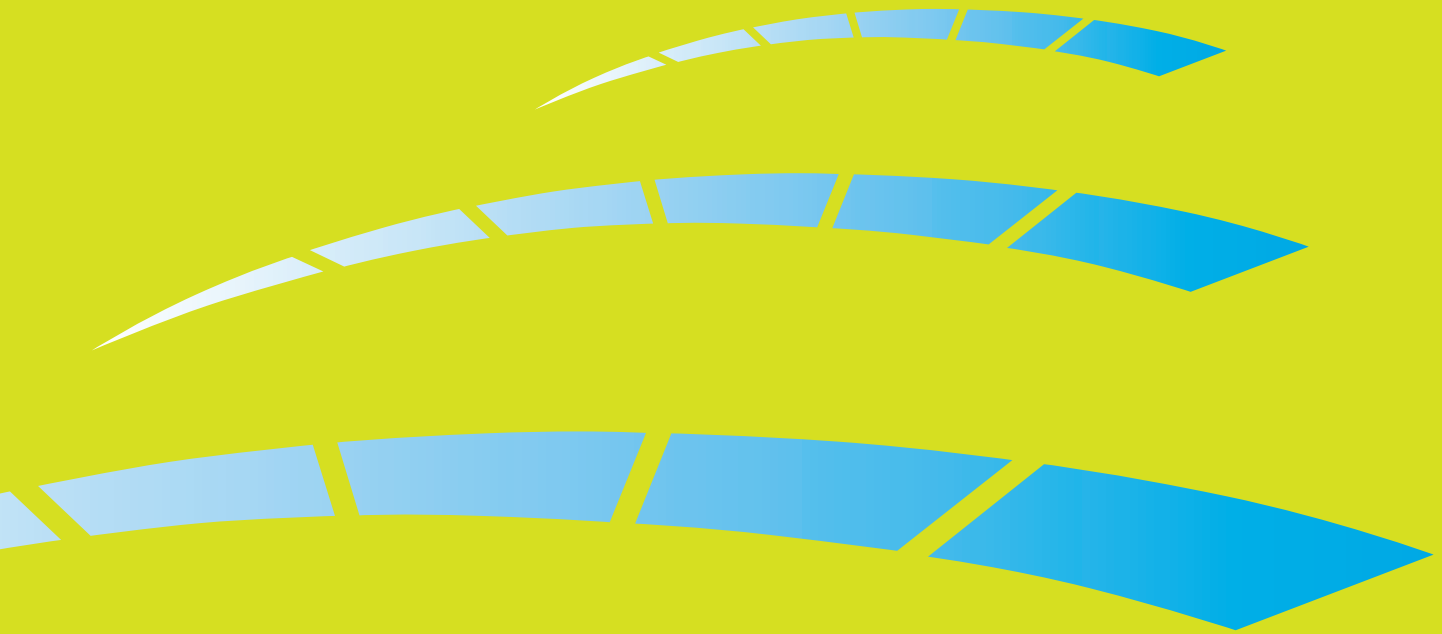

TECHBAR™ marks the evolution of the support bar system.

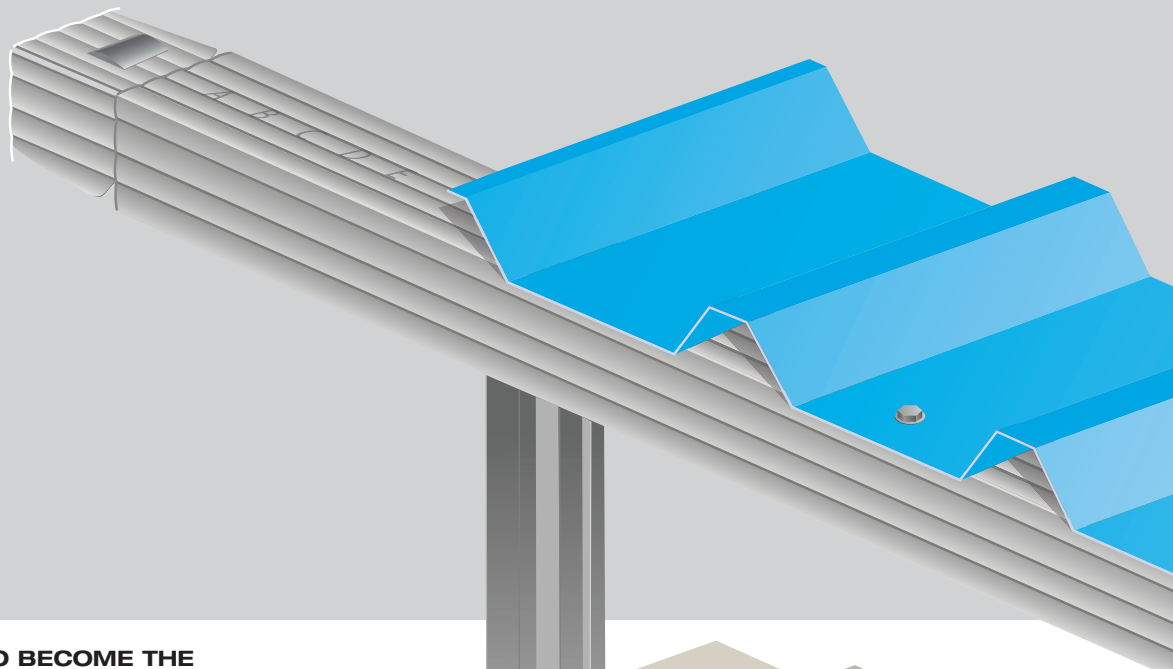

TECHBAR™ IS SET TO BECOME THE FIRST CHOICE FOR SUPPORTING TWIN SKIN & BUILT UP CONSTRUCTIONS.

THE FEATURES OF TECHBAR™

- Four ribs offer superior strength and greater pullout performance
- Alphabetical TGB bracket location guide on every bar
- Bar to bar connecting for extra strength and stability.
- Advancements in galvanising result in higher quality components
- Thermal check-pad also creates air seal to liner
- May be fitted vertically for horizontal cladding
- Standard and bespoke range of bracket and bar sizes

THE BENEFITS OF TECHBAR™

- Bracket manufactured from 1.6mm thick Z39 high tensile galvanised steel
- Faster yet more accurate to assemble, easy to fix in place
- More cost effective, reliable and safer to use **TECHBAR™**
- Advancements in the engineering and production process have increased the quality, strength, stability and durability of **TECHBAR™**
- Extensive technical support service including design and consultation
- Product has been independently tested
- Certified for 4 hour firewall use

The launch of **TECHBAR™** marks a new and innovative time for the concept of the support bar system. Used for both new build and refurbishment applications, the high performance design and enhanced features of the **TECHBAR™** system offer the roofing and cladding industry a far superior solution. Whether for new build or refurbished, for metal cladding of walls and roofs **TECHBAR™** provides the complete energy efficient solution, designed to surpass the latest building regulations.

Standard Bracket Heights (mm)

60, 80, 90, 100, 110, 120, 130, 140, 150, 160, 170, 180, 190, 200, 210, 220, 230, 240, 250, 260, 270, 280

(Other heights can be produced by arrangement)

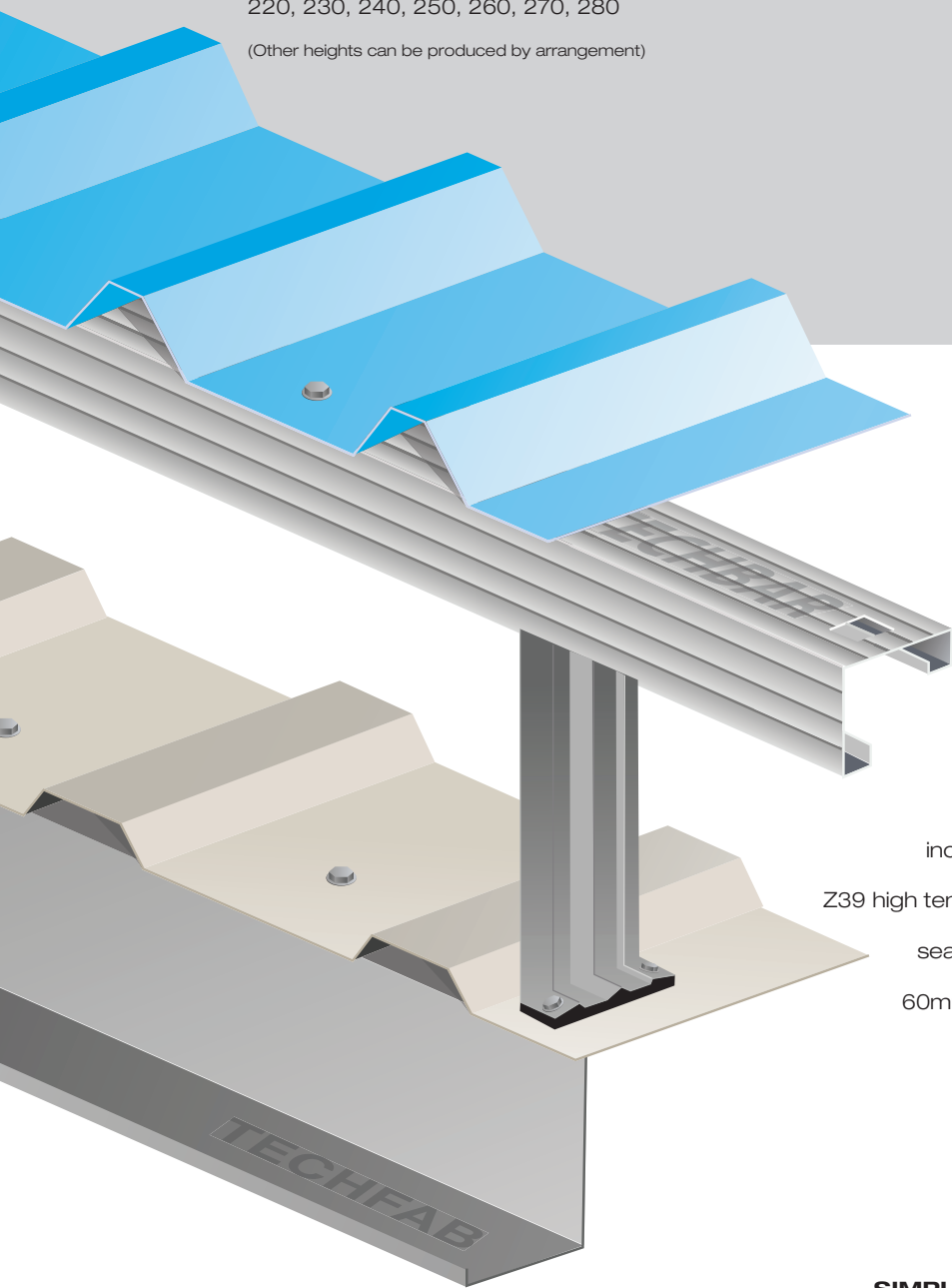

TECHBAR™ SUPPORT BAR

With the increased number of ribs for higher strength. Manufactured from high quality 1.25mm Z39 high tensile galvanised steel to EN 10147, Available in lengths of 1,2 and 3m from stock. Other lengths by arrangement.

TECHBAR™ BRACKET

Improved design and added ribs mean increased strength. Manufactured from 1.60mm Z39 high tensile galvanised steel to EN 10147, with vapour seal pad/thermal insulator. Heights available from 60mm-280mm. Additional heights are available by special arrangement.

SIMPLE ASSEMBLY

Advancements in production facilities mean better installation
Engage the lower bracket tab into the bar at the required location. Twist the bracket to engage the upper tab into the bar and continue twisting to lock the bracket into place.





TECHBAR™ guide to installation

TECHBAR™ has been designed to surpass the ever increasing demands of building regulations (Parts ADL1&2) but also with a view to aiding the installer during the often dangerous construction stage.

The construction phase is the most dangerous and the health and safety of the installer has become a major factor in the design of **TECHBAR™**. From the connecting ends to the improved design of the actual bar and bracket the safety of the installers is at the forefront of our design.

BASIC FIXING PROCEDURE

Install profiled lining sheets to the structural purlins/rails with **TECHFIX™** self-drilling fasteners; ensure that the liners are sealed correctly to obtain effective air movement control. For refurbishing older roofs, treat the old top sheet as the liner, and fit the new roof over the top.

TECHBAR™ brackets are twist-locked into the **TECHBAR™** at intervals of approx. 1 metre to suit the liner profile. The locating guide that is printed on each bar will assist with the setting out at regular intervals. A bracket should be positioned within 100mm of the bar end joint. The assembly is positioned on the roof and fixed through the bracket base and liner and into the purlin with two **TECHFIX™** self-drilling fasteners per bracket.

Insulation, when required, is rolled out on to the liner, dressing around the **TECHBAR™** bracket and under the bars to achieve continuous cover. (For Firewall applications this procedure differs, technical data available upon request) The top sheets are laid on to the **TECHBAR™** and fastened down, using the **TECHFIX™** self- drilling fasteners.

VERTICAL TECHBAR™

The sheeting rail spacing and building design will dictate the position of the bars, which must be supported on a structural member. For further information on vertical installation, please contact our technical support department.

SEE PAGE 9 FOR BAR AND BRACKET ASSEMBLY GUIDE

Standing Seam

TECHBAR™ has been designed for standing seam halter systems to achieve a u-value of 0.25w/m²k in compliance with the requirement of ADL1&2. The **TECHBAR™** engineered system is designed to minimise cold bridging and sound transmission. **TECHBAR™** is designed to accommodate the greater thickness of insulation and longer sheet lengths now being specified, by resisting the movement forces these applications may impose. **TECHBAR™** brackets involve minimal metal to metal contact by the inclusion of a thermal break pad at the base. In a typical standing seam build up, the aluminium halters are fixed at 300mm or 400mm centres thereby bridging the roof construction. When incorporating the **TECHBAR™** support bar system into the roof build up, the effect of multiple thermal bridging is reduced, due to the fact that the support bracket can be fixed at 1000mm centres. This in turn can reduce the thickness of insulation necessary resulting in a roof construction that is structurally sound and easily meets thermal performance requirements.

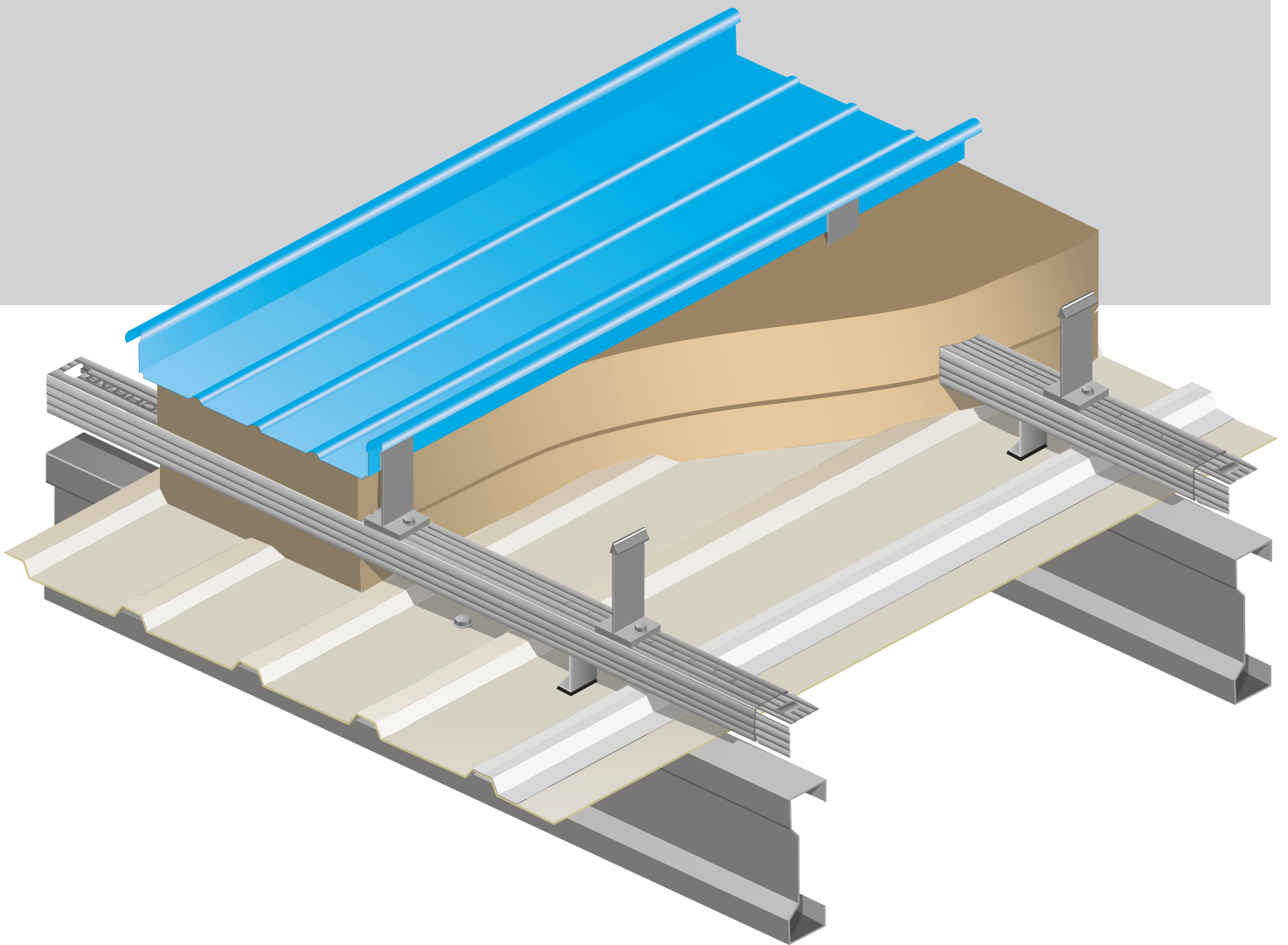

WOODALL FS
FASTENING SYSTEMS

TECH
FASTENERS

WOODALL BS
BUILDING SYSTEMS

Vertical Sheeting on **TECHBAR™**

Using **TECHBAR™** spanning along principal cladding rails with brackets at 1.0m and 1.2m enables the cladding contractor to quickly and efficiently install vertical claddings.

The **TECHBAR™** brackets are twisted into the support bar at the appropriate centres - 1.0m to 1.2m - aided by the bracket location guide permanently marked on every bar. The completed assembly is then offered up to the liner panels and fixed using two **TECHFIX™** self drilling screws through each bracket.

With typical cladding rail centres at 1.8m and brackets spaced at 1.2m centres, service wind loads in excess of 1.0kN/m² can be resisted. Insulation is fitted under the **TECHBAR™** system and secured using self-adhesive stickpins except where fire conditions dictate a more robust fixing detail.

The bracket foot is insulated from the liner panel / cladding rail via the thermal break pad on its underside, which also assists in achieving satisfactory air seal continuity.

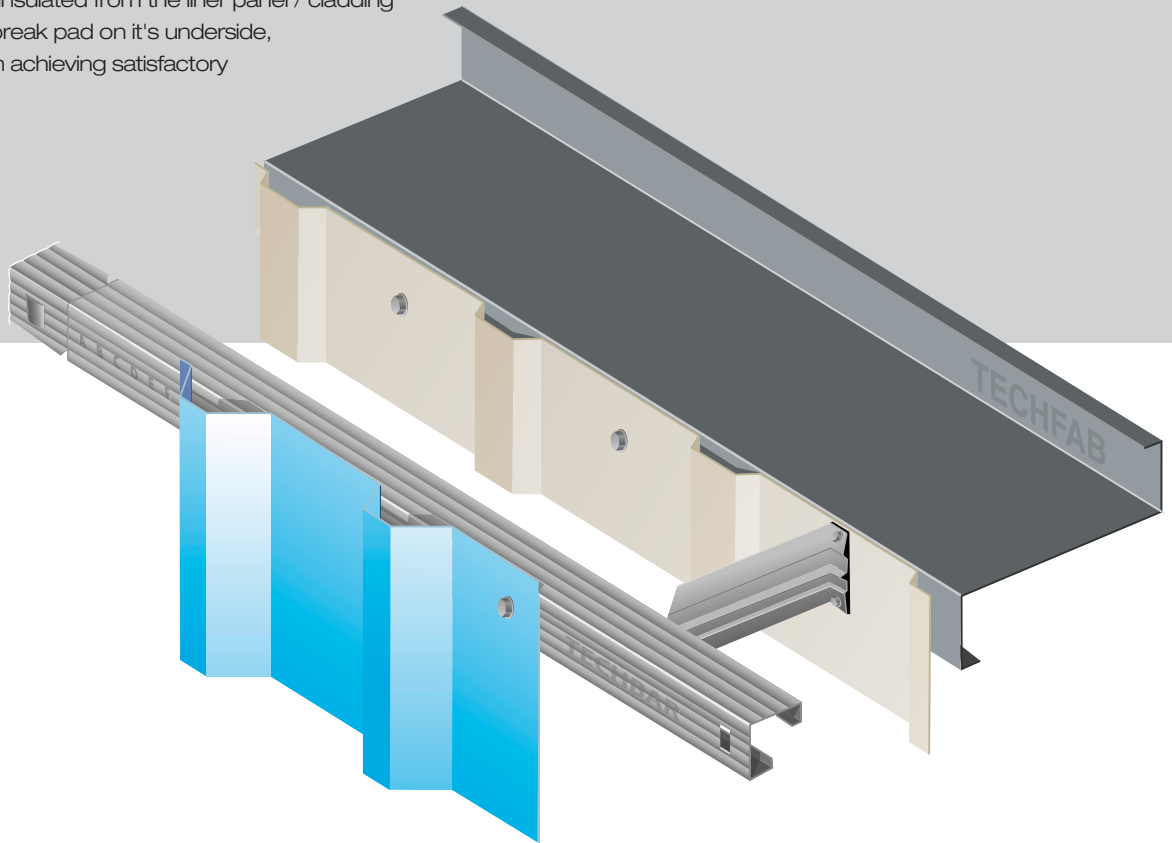

Horizontal Sheeting on Top-hats

We have also developed an innovative top-hat system for spanning vertically across the cladding rails to support horizontal sheeting. These vertical bars can be made continuous by using splice joints. The top-hats are fixed on to bespoke TechWall Brackets with two self drilling fasteners (one per side). The TechWall Brackets are then fixed to the sheeting rail with two or more **TECHFIX™** self drilling fasteners. This detail superbly distributes vertical load over all the sheeting rails. The TechWall vertical top-hat system provides excellent structural performance. With a general wind loading of 1kN/m² and typical rail centres of 1800mm, the TechWall system requires vertical top-hats at 1400mm c/c. Depending upon wind loading bars can be as far apart as 3000mm.

The **TECHBAR™** support bar system allows insulation quilt to be laid with the minimal compression under the **TECHBAR™** and around the brackets. It includes a thermal break on the base bracket to minimise cold bridging and energy loss.

Using typical twin skin components, **TECHBAR™** will meet the requirements of the building regulations - Part L2 - without difficulty. **TECHBAR™** brackets, being well spaced out across the roof do not cause significant cold bridging.



Horizontal Sheeting on **TECHBAR™**

TECHBAR™ has been designed for vertical application of horizontal wall cladding with bracket depths up to 140mm and rail centres up to 2000mm apart. To achieve a safe working load of 1kN/m² using **TECHBAR™** in multiple spans across the cladding rails, spaced at 2000mm in relation to the overall height of the building, it may be necessary to fix the **TECHBAR™** at 600mm centres along the wall. However it must be noted that the extended length of brackets may result in some deflection of the cladding. Whilst the **TECHBAR™** twist and lock system results in a good interference fit, in vertical applications it is necessary to provide additional anti-sag measures to prevent excessive deflections. When the fitted system is supported at suitable intervals it ensures that the weight of the cladding is transferred to the structure. Solutions available include supporting the base of the bar on a structural steel member, or fixing to a top-hat or simple cleat to stabilise the bar in addition to standard brackets to the cladding rail.

NOTE:

For sheeting rail centres up to 1800mm the **TECHBAR™** system can be fitted as illustrated but attention must be paid to loads and deflections.

CONTACT OUR TECHNICAL DEPARTMENT FOR FURTHER INFORMATION REGARDING SPACING OF TECHBAR™

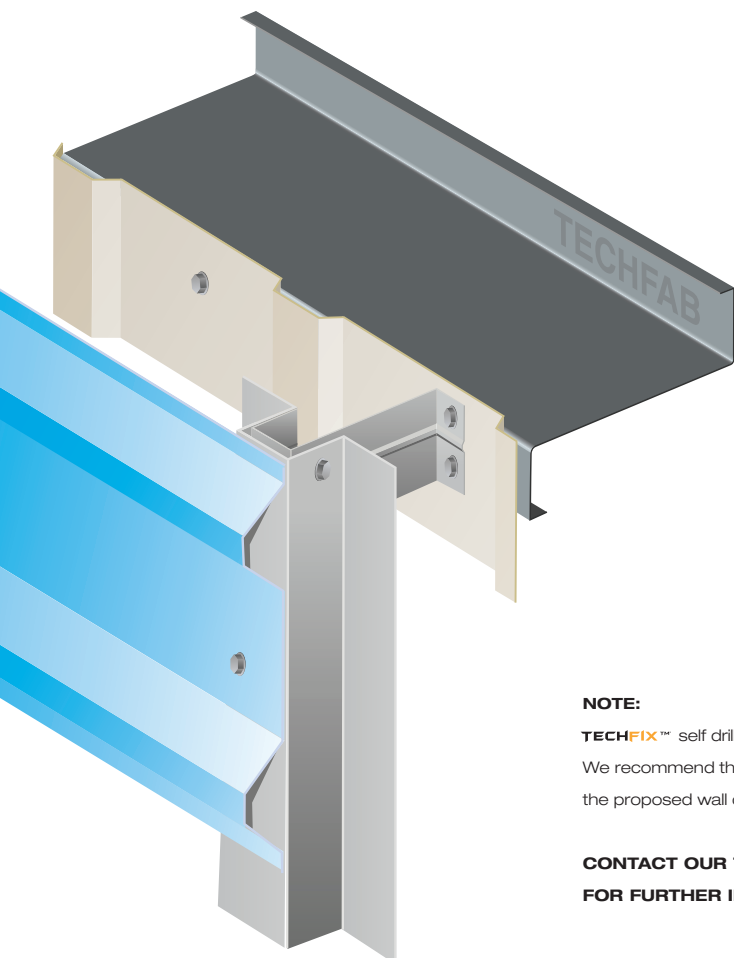
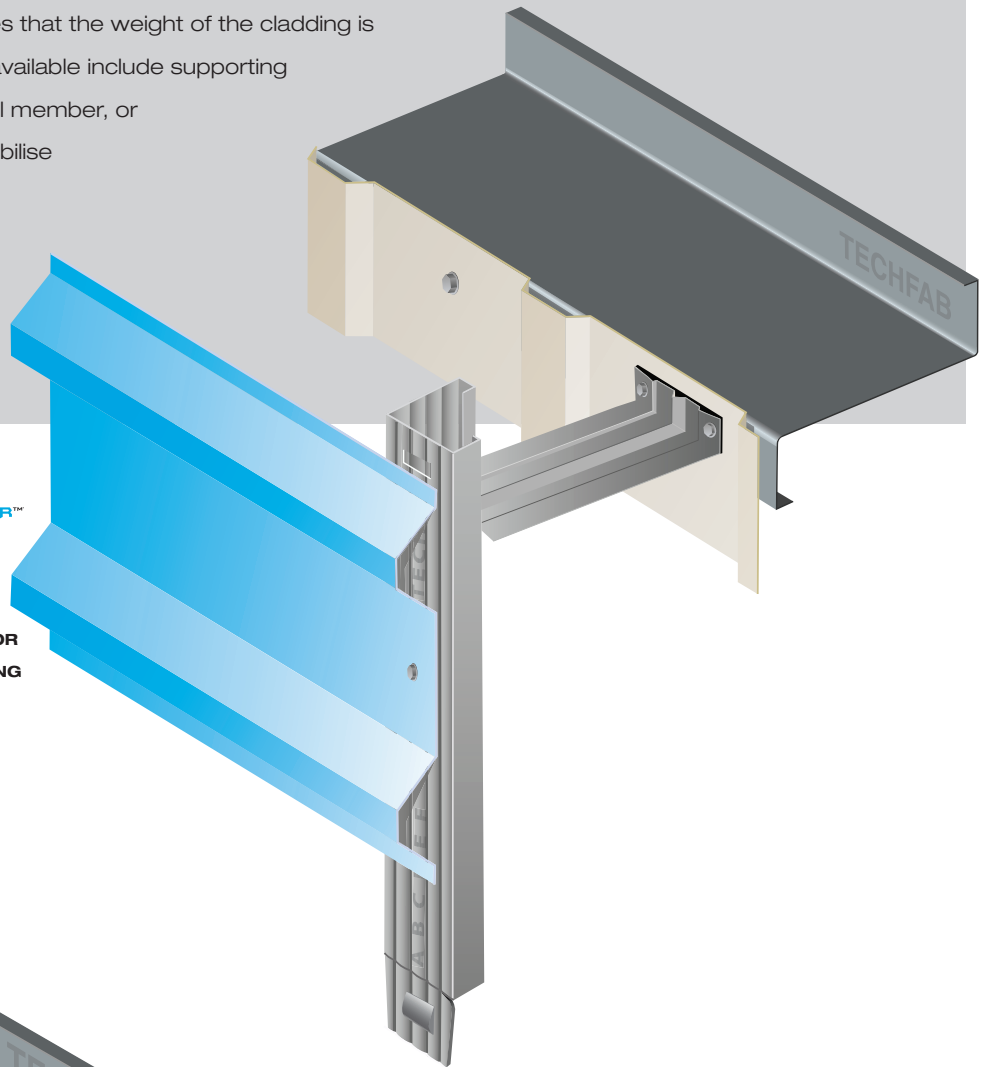

NOTE:

TECHFIX™ self drilling fasteners used for sheeting. We recommend that a structural engineer approves the proposed wall detail.

CONTACT OUR TECHNICAL DEPARTMENT FOR FURTHER INFORMATION



Firewall Application

FIREWALL TO COMPLY WITH ADL 1 & 2 THE BUILDING REGULATIONS

The objective of the firewall is to act as a barrier to the spread of fire and rigorous testing was carried out to ascertain how long it can retain its stability. The regulations state limits for how long the wall must remain stable and how long the insulation must last. This is important to inhibit the spread of the fire to enable a building to be safely evacuated. It is therefore imperative that the firewall is constructed in accordance with the tested sample as any deviation may result in the firewall not performing as expected.

Building Regulations define clearly the minimum fire safety requirements of building elements/requirements in two ways:

- Resistance to fire
- Reaction to fire

The basic concepts are the same in all regions of the UK and Ireland. Because of its strength, pre-finished steel roof and wall cladding complies very easily with the fire regulation in most cases.

THE BASICS

Fire performance requirements are a function of:-

- Building use, for example; commercial, industrial or residential
- Building storey area. The storey area, jointly with the building type, defines whether compartments are or are not required.

- Building Height: There are different provisions for high rise buildings. High rise buildings are considered to be over 18 metres in height.
- Building Location: Boundary buildings, i.e. those less than 1 metre from a boundary wall have different provisions in terms of the external surface of walls and performance of roof coverings.

Based on these criteria, the requirements are expressed in terms of minimum fire performance in up to three areas:

- Fire Resistance. This applies to systems such as panels and profiles rather than building materials. It measures the ability of a system to prevent the penetration of hot gases and flames as well as it's ability to reduce the temperature rise on the unexposed side of the wall and therefore prevent fire spread through conducted heat.
- The performance of roofs in terms of exposure to external fire.
- Surface spread of flame/reaction to fire.

Performance is measured in tests defined in BS476, the British Fire Testing Standard.

Built up systems if appropriately designed, will meet the regulation requirements. Cladding manufacturers publish the fire performance of each of their systems.

For the building envelope, built up systems or insulation (PIRs or mineral and glass fibre) can meet the requirements of the building regulations or the insurers, provided they have been properly designed.

Wall Construction / Installation

INSTALLATION

The **TECHBAR™** and bracket is fixed to the liner sheet, the **TECHBAR™** 'firewall' bracket is supplied with an additional intumescent pad, and the rockwool is retained using traditional stickpins and fitted beneath the **TECHBAR™**.

The basic wall construction is specifically for use on firewalls sited 1 metre or more from a boundary.

The laps of the weather sheet need to be stitched with screws at 300mm centres and liner panel should be riveted using steel rivets at 300mm

FIREWALL TEST



FIREWALL AFTER 29mins



FIREWALL AFTER 38mins

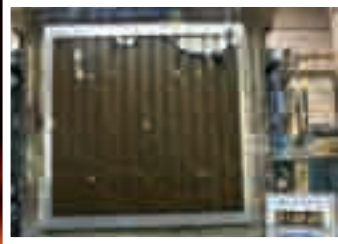

FIREWALL AFTER 1 HOUR



FIREWALL AFTER 1.47 HOUR



FIREWALL AFTER 2.31 HOUR



FIREWALL AFTER 4.00 HOUR



FIREWALL AFTER 4.24 HOUR



FIREWALL AFTER END OF TEST

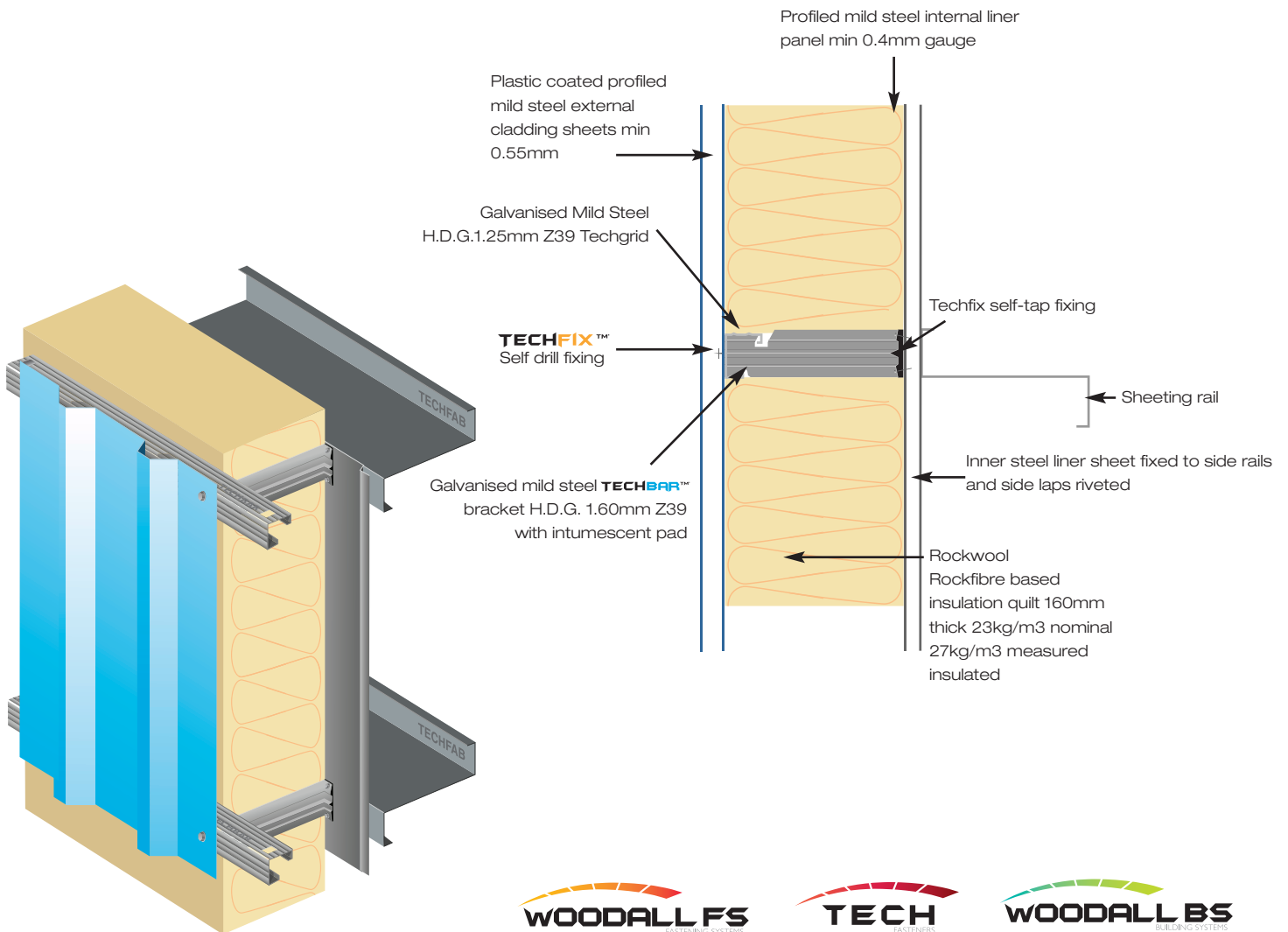

BRACKETS @ 1000MM C/C POSITIVE LOADING (GRAVITY) ROOF & WALLS - BARS RUNNING HORIZONTALLY

Rail c/c	500mm	1000mm	1100mm	1200mm	1300mm	1400mm	1500mm	1600mm	1700mm	1800mm	1900mm	2000mm
Roof SWL kN/m2	4.54	2.27	2.06	1.89	1.75	1.62	1.52	1.42	1.34	1.26	1.2	1.14
Wall SWL kN/m2	5.18	2.59	2.35	2.16	1.99	1.85	1.73	1.62	1.53	1.44	1.37	1.3

BRACKETS @ 1000MM C/C NEGATIVE LOADING ROOF & WALLS - BARS RUNNING HORIZONTALLY

Rail c/c	500mm	1000mm	1100mm	1200mm	1300mm	1400mm	1500mm	1600mm	1700mm	1800mm	1900mm	2000mm
Roof SWL kN/m2	3.38	2.34	2.13	1.97	1.8	1.67	1.56	1.46	1.38	1.3	1.23	1.17
Wall SWL kN/m2	3.38	2.34	2.13	1.97	1.8	1.67	1.56	1.46	1.38	1.3	1.23	1.17

BRACKETS @1100MM C/C POSITIVE LOADING (GRAVITY) ROOF & WALLS - BARS RUNNING HORIZONTALLY

Rail c/c	500mm	1000mm	1100mm	1200mm	1300mm	1400mm	1500mm	1600mm	1700mm	1800mm	1900mm	2000mm
Roof SWL kN/m2	4.06	2.03	1.85	1.69	1.55	1.45	1.36	1.27	1.19	1.13	1.07	1.02
Wall SWL kN/m2	4.63	2.31	2.11	2.05	1.77	1.65	1.55	1.45	1.35	1.29	1.22	1.16

BRACKETS @1100MM C/C NEGATIVE LOADING ROOF & WALLS - BARS RUNNING HORIZONTALLY

Rail c/c	500mm	1000mm	1100mm	1200mm	1300mm	1400mm	1500mm	1600mm	1700mm	1800mm	1900mm	2000mm
Roof SWL kN/m2	3.38	1.98	1.81	1.66	1.53	1.42	1.33	1.25	1.17	1.1	1.04	1.51
Wall SWL kN/m2	3.38	1.98	1.81	1.66	1.53	1.42	1.33	1.24	1.17	1.1	1.04	1.51

BRACKETS @ 1200MM C/C POSITIVE LOADING (GRAVITY) ROOF & WALLS - BARS RUNNING HORIZONTALLY

Rail c/c	500mm	1000mm	1100mm	1200mm	1300mm	1400mm	1500mm	1600mm	1700mm	1800mm	1900mm	2000mm
Roof SWL kN/m2	3.38	1.79	1.63	1.49	1.34	1.28	1.2	1.12	1.05	0.9	0.94	0.89
Wall SWL kN/m2	4.09	2.04	1.86	1.7	1.53	1.46	1.37	1.27	1.19	1.13	1.07	1.01

BRACKETS @ 1200MM C/C NEGATIVE LOADING ROOF & WALLS - BARS RUNNING HORIZONTALLY

Rail c/c	500mm	1000mm	1100mm	1200mm	1300mm	1400mm	1500mm	1600mm	1700mm	1800mm	1900mm	2000mm
Roof SWL kN/m2	3.24	1.62	1.48	1.35	1.25	1.16	1.09	1.02	0.96	0.9	0.85	0.81
Wall SWL kN/m2	3.24	1.62	1.48	1.35	1.25	1.16	1.09	1.02	0.96	0.9	0.85	0.81

NOTES:

- 1) All loads are safe working loads i.e. Unfactored Service Loadings.
- 2) Steel used is Z39 with a minimum yield stress of 390N/mm²
- 3) Deflection is limited to span/200 for all load zones
- 4) Uplift loads do not exceed the capacity of 2 No 5.5mm diameter screws in 1.6mm thick steel
- 5) Load factors of 1.4 for dead loadings and 1.6 for superimposed loadings (including wind)

Assembly Guide

Movement 1

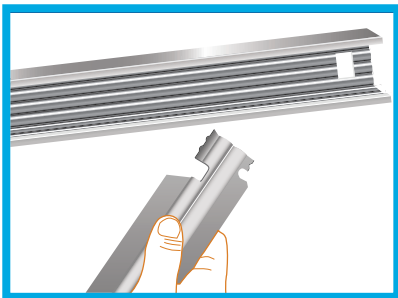

Movement 2

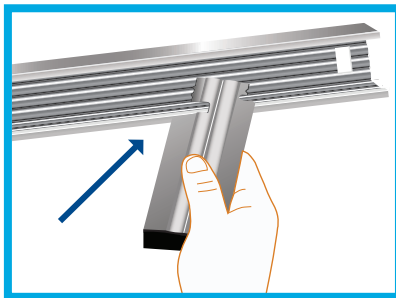

Movement 3

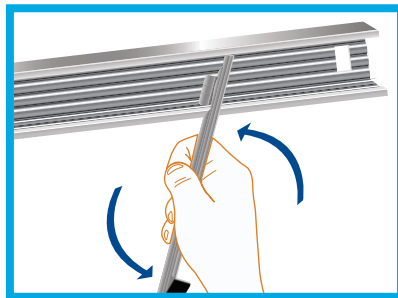

Movement 4

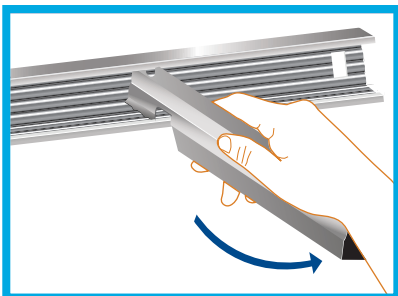

Movement 5

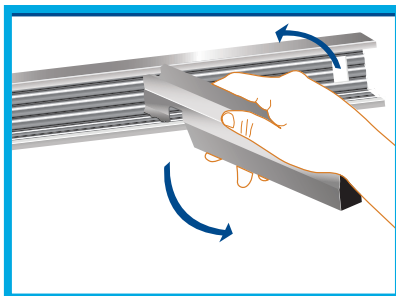

SIMPLE ASSEMBLY

Advancements in production facilities mean better installation. Engaged the lower bracket tab in to the bar at the required location. Twist the bracket to engage the upper tab in to the bar and continue twisting to lock the bracket in to place.

TECHBAR™ being tested at Ceram test house in accordance with the industries' procedure.



Disclaimer

Responsibility for errors or omissions cannot be accepted, this catalogue is produced and issued as a product profile reference manual and should not be used as a technical reference or suggested installation method manual. All photographs are for guidance only and do not necessarily represent the products illustrated.



Woodall Building Systems
Unit 18B Brewins Way, Off Narrowboat Way,
Hurst Busines Park, Brierley Hill,
West Midlands, DY5 1UY. England
Tel: 01384 473500 Fax: 01384 484097
Email: fabs@techscrew.com
www.techscrew.com



Tech Fasteners Ltd.
Unit 18/2, Clondalkin Industrial Estate,
Dublin 22, Ireland
Tel: 00 353 1 4573300
Fax: 00 353 1 4570470
Email: sales@techfasteners.ie
www.techfasteners.ie



Woodall Fastening Systems
Unit 30, Navigation Drive, Hurst Business Park,
Brierley Hill, West Midlands. DY5 1UT. England
Tel: 01384 263900 Fax: 01384 263908
Email: wfs@techscrew.com
www.techscrew.com